

Sensor solutions for packaging machines

Improving your machine and plant performance

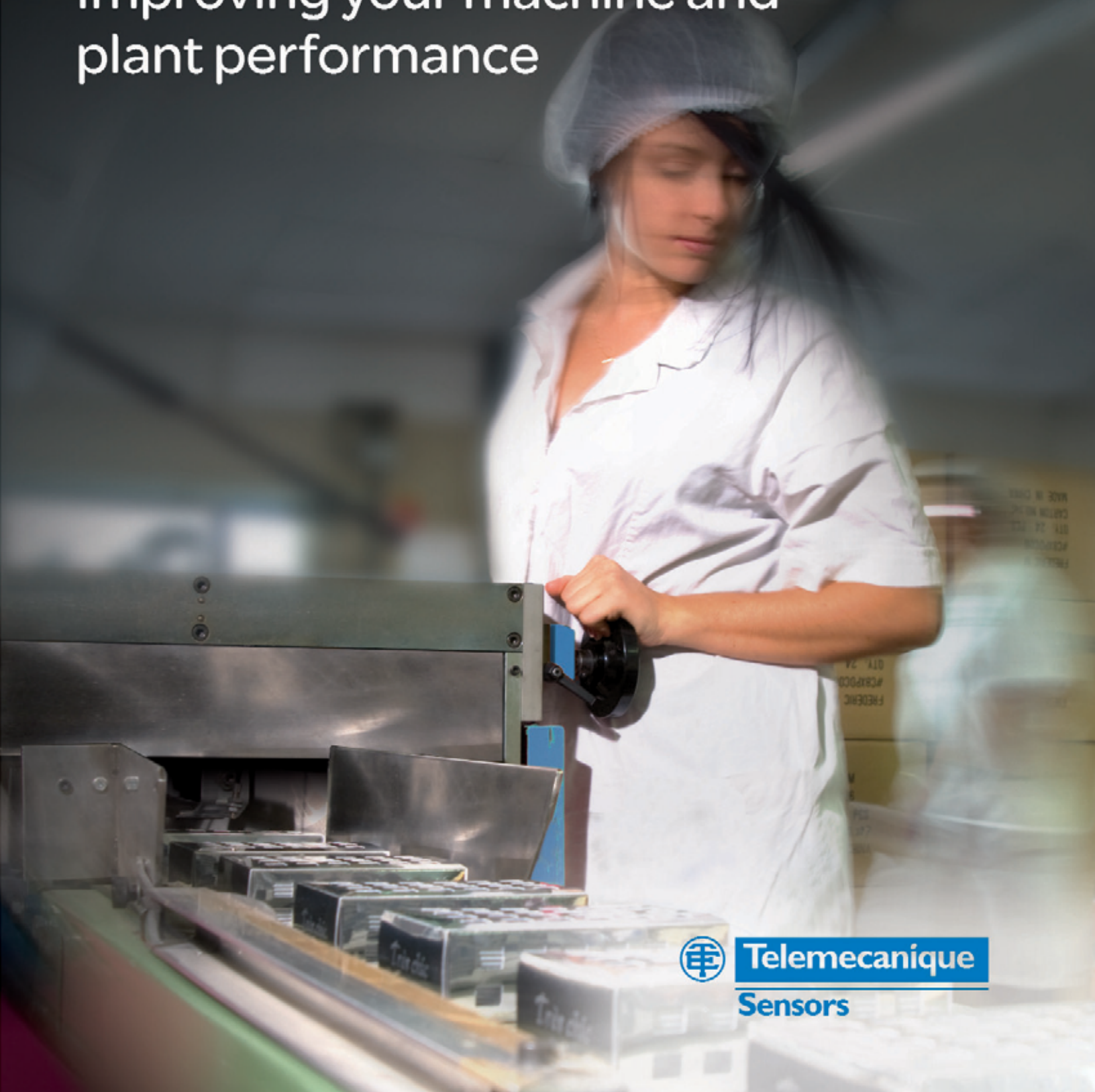

Telemecanique

Sensors

Telemecanique Sensors

“Making sense of sensors”

Our products

- **Telemecanique Sensors:** A world-class global brand offering a comprehensive line of products with over 25,000 types of sensors: Including limit switches, pressure sensors, photo-electric and proximity sensors. In addition we provide state of the art RFID systems that are tightly integrated with many PLC manufactures, as well as industrial encoders.
- **Telemecanique Sensors:** Known for high quality and superior performance. Telemecanique is second to none, and has all the right agency approvals such as: (IEC, NEMA, CE, CCC, UL, CSA).

Our sales team

- **A dedicated Sales team:** Trained and experienced sales professional are available to help you with any sensing application.
- **Telemecanique Sensors teams:** Support teams are available for pre- and post-sales support, we become an extension of your team to share our expertise with you.

Localized Manufacturing

- **High volume manufacturing:** Manufacturing is located in each of the major markets of Europe, North America and Asia to ensure prompt delivery, and short lead times to our local distribution centers worldwide.
- **Regional Flex-Centers** enable fast response and quick delivery of customized and speciality products services.

Availability and reliability

- **A worldwide supply chain with a network of local distribution centers** ensure the availability of Telemecanique Sensors and allow us to be a reliable supplier and partner.

Discover

Our comprehensive range of products



The expertise of the competency centers



Localized production and customization



Our logistics are designed to meet your needs



Worldwide availability and support

Product range specialized for food and beverage

Telemecanique Sensors offers special versions for food and beverage applications. With the highest protection degree (IP69K) and housings in stainless steel (316L) the products are certified by the Ecolab laboratory:

- Comprehensive offer of inductive sensors
- Comprehensive offer of cables and accessories

NEW: Photo-electric sensor range in compact design
50 x 50 mm XUKS

NEW: Incremental and absolute encoders XCC



New sensors in miniature design

Packaging machines are getting more and more compact. The size of a sensor plays a large role during the construction of the machine. Telemecanique Sensors offers a complete range of sensors in miniature design – the XUM family comprises:

- Through beam sensors
- Reflex sensors
- Diffuse sensor
- Laser sensors

NEW: Diffuse sensors with visible red-spot and precise background suppression – XUM8

NEW: Sensors for the precise detection of transparent materials – XUMT



Sensor applications for packaging machines

Packaging machines have to be faster and more flexible. They have to solve more complex automation tasks than ever before. Therefore, as a machine builder, it is so important for you to tread new and innovative paths in order to produce energy efficient machines, reduce development costs and bring your machines much faster to the market.

- > Following pages show examples of applications in which our sensors are used. For detailed technical data, please consult our Sensors website at: www.schneider-electric.com

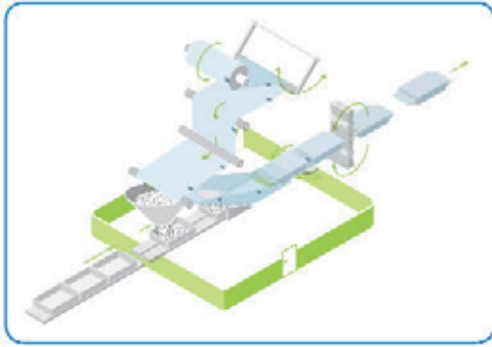

> Form, Fill, and Seal machines

6/7



> Labeling machines

8/9

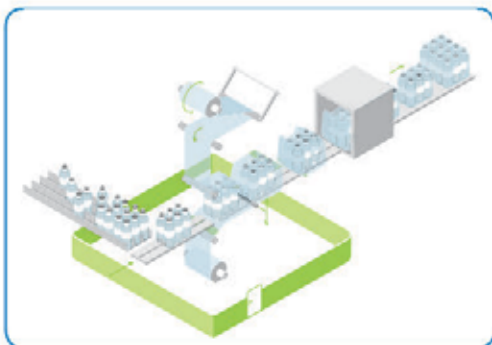

> Shrink Wrapping machines

10/11



> Case Packing machines

12/13

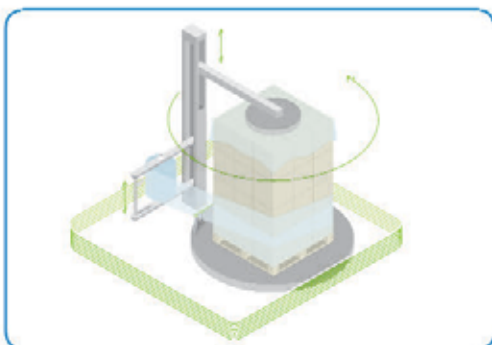

> Stretch Wrapping machines

14/15

Form, Fill, and Seal machines – Components and Functions

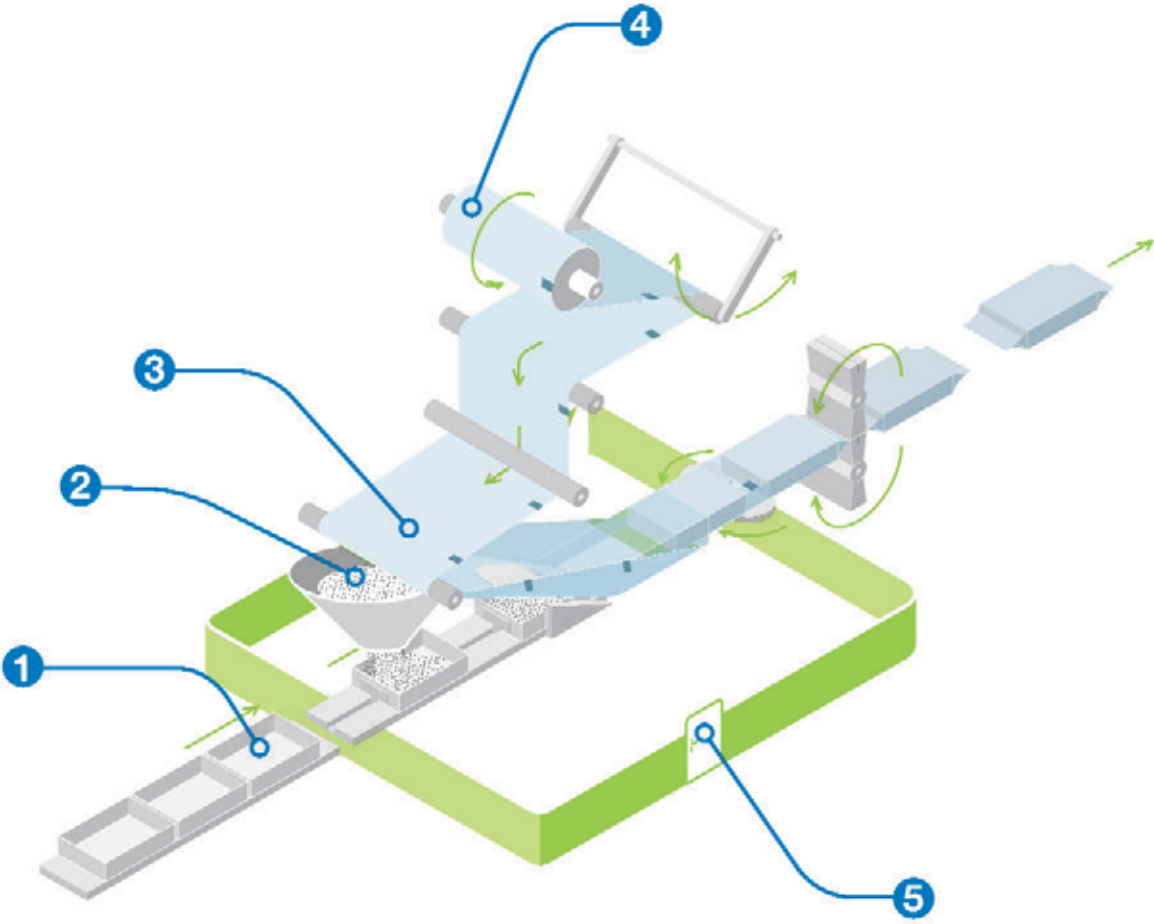

> Typical sensors applications:

Our solution:

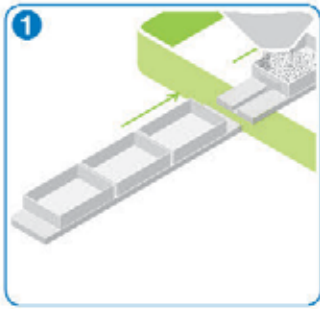

> Grouping/Ungrouping

- The standards used are photo-electric sensors in compact design XUK 50 x 50 mm, miniature design XUM 32 x 20 mm or cylindrical M18 sensors XUB.
- **NEW:** XUKS in stainless steel for the packaging of foods and beverages.

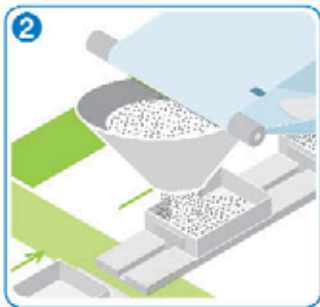

> Detection of the goods being filled

- To detect the powdered goods, capacitive sensors are used.
- **NEW:** XT2 – a complete range of capacitive sensors from M12 to Ø 30 mm. Best choice for the best price.
- The XUF Frame Sensors are an excellent choice for detecting or counting parts or goods. Objects as small as 2mm in diameter can be sensed!

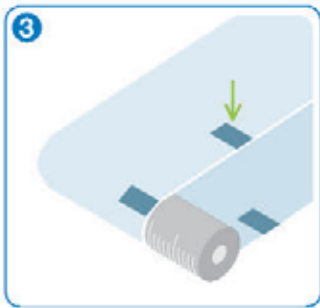

> Mark detection

- The detection of print marks are made by contrast sensors. The mark reader XUKR in compact size 50 x 50 mm and XUY in miniature design 32 x 20 mm are easy to mount and easy to teach.



> Film presence

- To detect the presence of the film or to get the permanent status the use of ultrasonic sensors XX are the best solution because transparency or color of the object have no influence.
Flat or cylindrical formats are available.
- **UNIVERSAL:** XX7V1 with solid state or XX9V1 with analog output, mountable with bracket or simply in a hole Ø18 mm.



> Safety control

- For the safety control of the doors mechanical or magnetical switches are used.
- **NEW:** XCSLE and XCSLF key operating switches with solenoid and escape function (optional), available in metal or plastic housing.



Labeling machines – Components and Functions

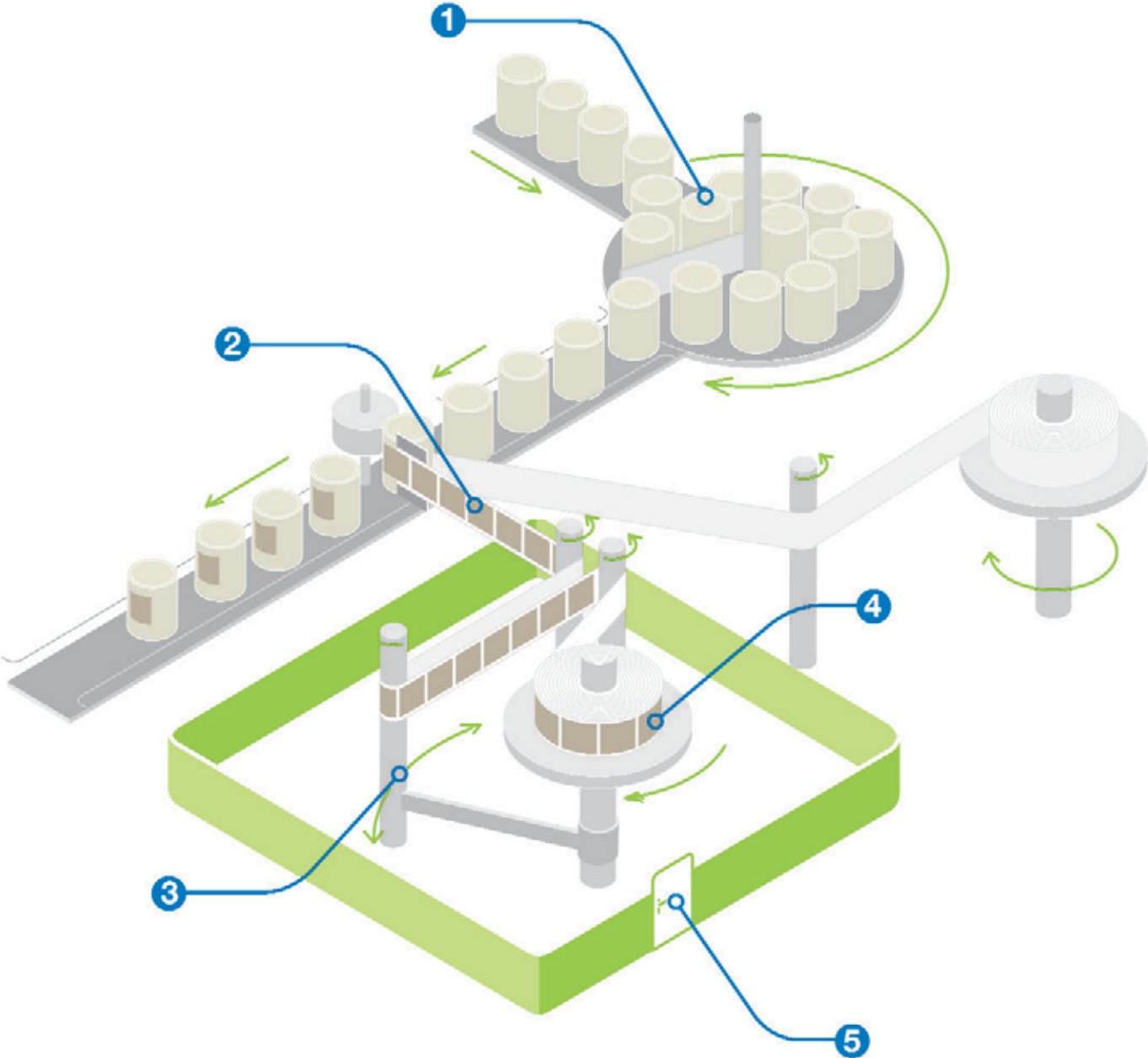

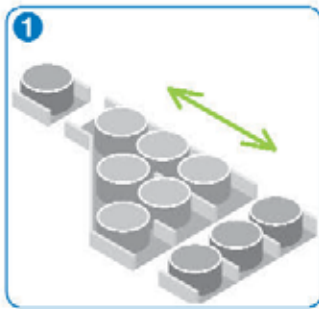

> Grouping/Ungrouping

- The standards used are photo-electric sensors in compact design XUK 50 x 50 mm or miniature design XUM 32 x 20 mm in reflex or diffuse mode.
- **NEW:** XUM8 – miniature diffuse sensor with visible red light and precise background suppression (1).

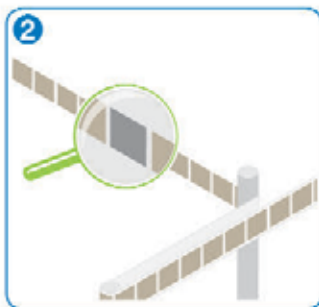

> Label detection

- For the synchronisation and detection of the label edge fork sensors are the best choice.
- **IDEAL for transparent labels:**
Ultrasonic fork sensors
- **NEW:** XUVE – High performance, highly economic (2).

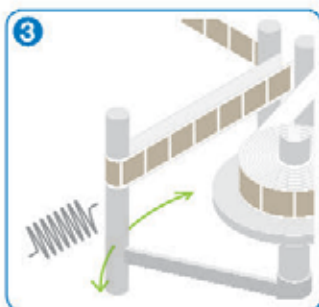

> Film tension

- The detection of the end positions of the excenter which is controlling the film tension is made with inductive sensors.
- **IDEAL:** Inductive sensors with analog output in cylindrical (XS4) or flat format (XS9).

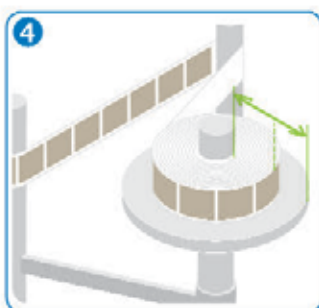

> Film presence or control

- To detect the presence of the film by measuring the radius photo-electric sensors can be used (e. g. XUM9). To get the permanent status the use of ultrasonic sensors XX is the best solution when labels are transparent or have different colors. Flat or cylindrical formats are available.
- **UNIVERSAL:** XX7V1 with solid state or XX9V1 with analog output, mountable with bracket or simply in a hole Ø 18 mm.



> Door-control

- For the safety detection of doors magnetic switches are a good solution.
- **IDEAL:** Compact magnetic switches with integrated safety control – best solution if only few safety devices are needed.



Shrink Wrapping machines – Components and Functions

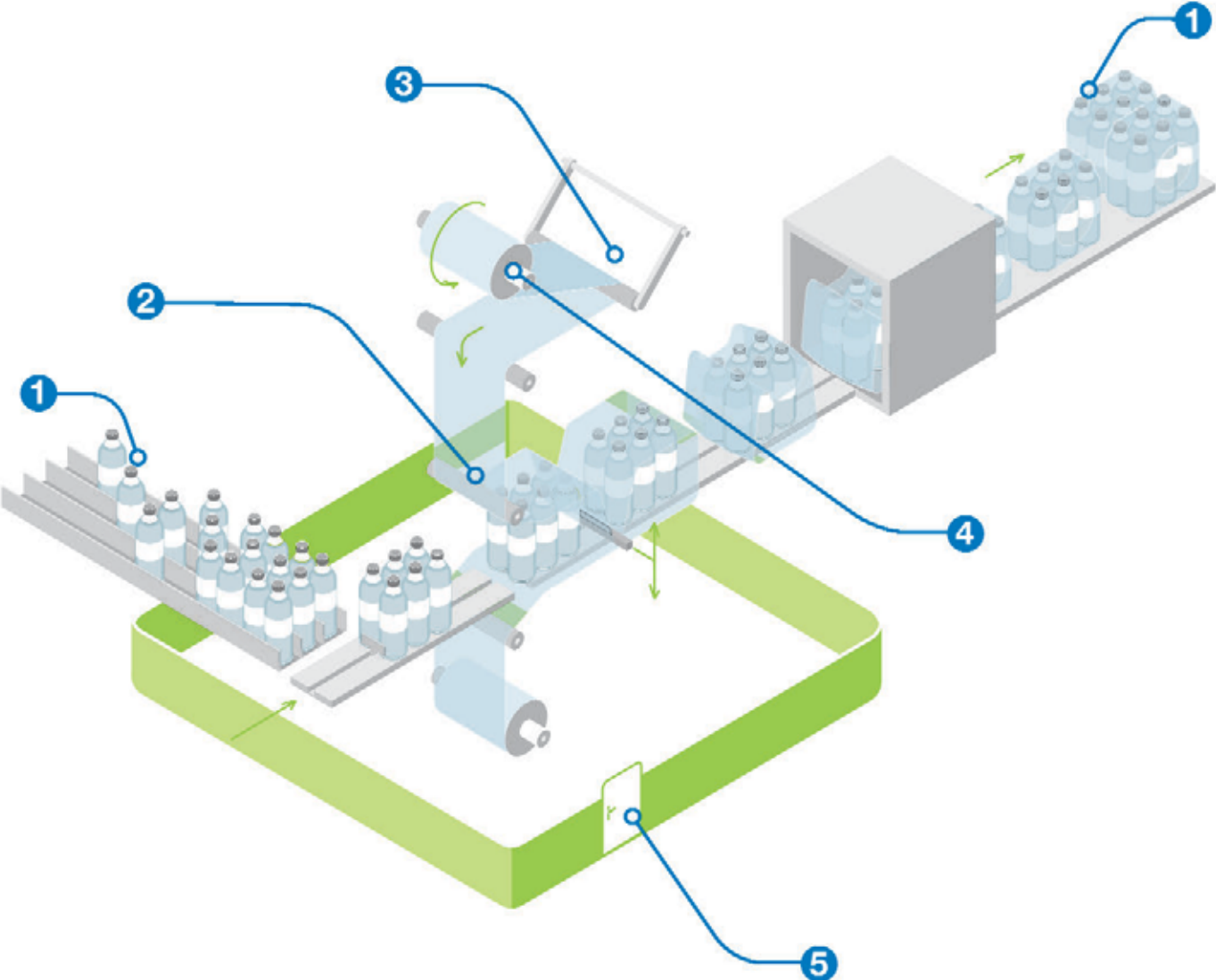

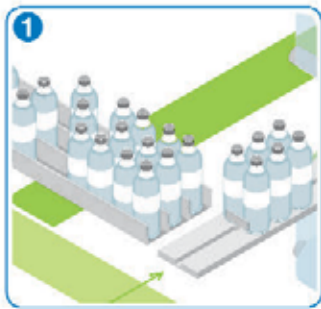

> Grouping/Ungrouping

- For the detection of transparent objects, like glass or PET bottles, special transparent sensors are needed.
- **Your choice:** XUKT in compact design 50 x 50 mm or XUBT in cylindrical format M18.
- **NEW:** XUMT in miniature design 32 x 20 mm (1)

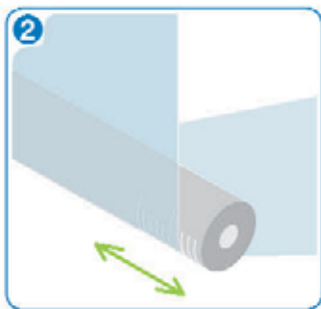

> Film positioning

- The positioning of the film on the feed roller is made by fork or angular fork sensors.
- **IDEAL:** For a high precision positioning: Laser fork sensors XUYF.

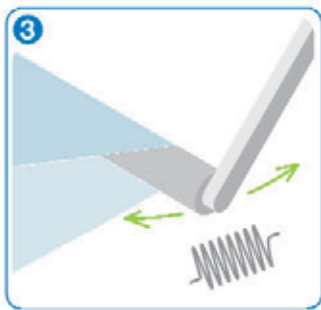

> Film tension

- The detection of the end positions of the tensioning arm which is controlling the film tension is made with inductive sensors.
- **IDEAL:** Inductive sensors with analog output in cylindrical (XS4) or flat format (XS9).

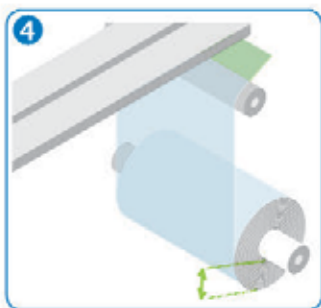

> Film presence or control

- To detect the presence of the film by measuring the radius photo-electric sensors can be used (e. g. XUM9). To get the permanent status the use of ultrasonic sensors XX is the best solution when labels are transparent or have different colors. Flat or cylindrical formats are available.
- **UNIVERSAL:** XX7V1 with solid state or XX9V1 with analog output, mountable with bracket or simply in a hole Ø18 mm.



> Door-control

- For the safety detection of doors guard switches are suitable.
- Depending on the environment plastic or metal housing is the best solution.
- **HERE:** Guard switches in typical versions.



Case Packing machines – Components and Functions

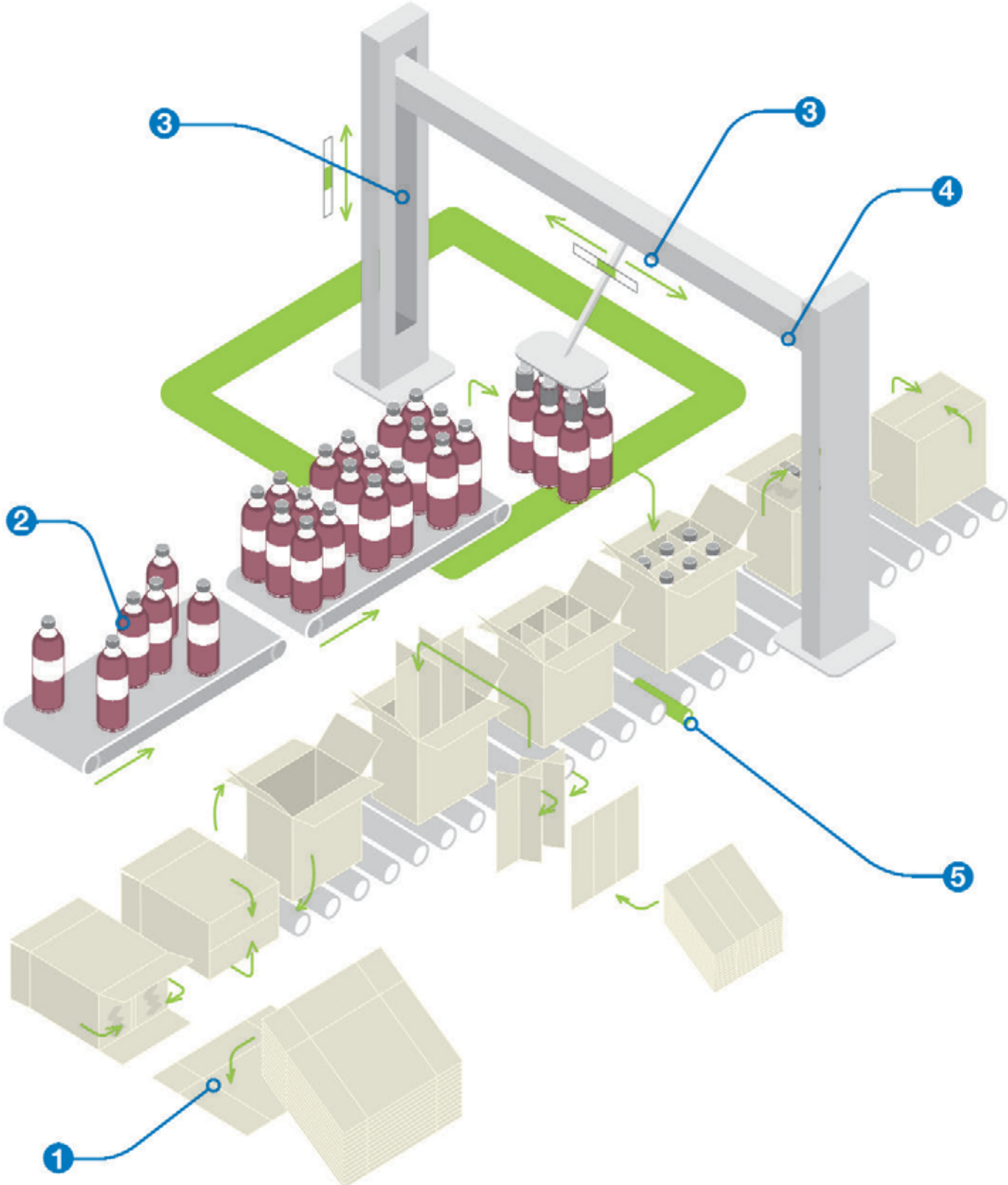

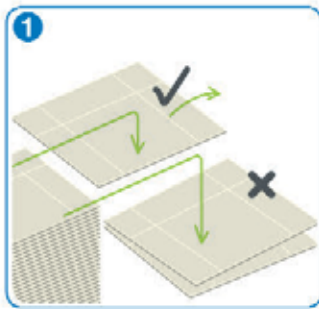

> Detection double case

- For the surveillance that only one carton is in the feeder a diffuse photo-electric sensor with high precision and which is not affected by colors is suitable.
- **IDEAL:** XUK8 with precise background suppression.
- **For higher precision:** Laser sensors in miniature (XUY PCO929) or compact design (XUY PS1).



> Grouping/Ungrouping

- For the detection of transparent objects, like glass or PET bottles, special transparent sensors are needed.
- **Your choice:** XUKT in compact design 50 x 50 mm or XUBT in cylindrical format M18
- **NEW:** XUMT in miniature design 32 x 20 mm (1).

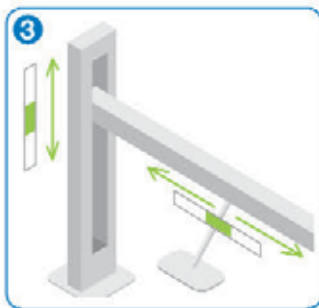

> Positioning

- The exact position in x or y direction is measured by incremental or absolute encoders.
- **NEW:** Encoder in stainless steel with IP69K for food industry.

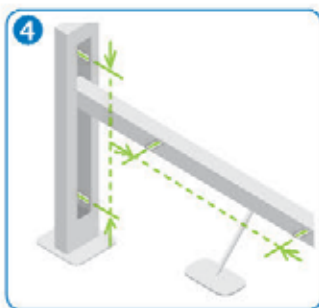

> Detection of the end positions

- To detect the end positions limit switches are the best choice.
- **IDEAL:** Compact limit switches XCKP or XCMD with modular design fit to all mechanical requirements.

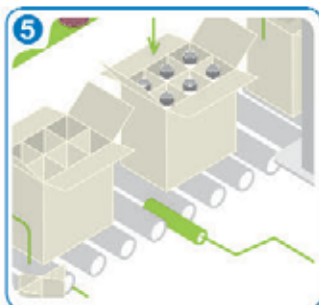

> Control of material flow

- The controlling of the material on a conveyor usually is realized with photo-electric sensors plus reflector.
- **NEW:** Roller sensor XUY (2) to build-in directly between two rollers of a conveyor.



Stretch Wrapping machines – Components and Functions

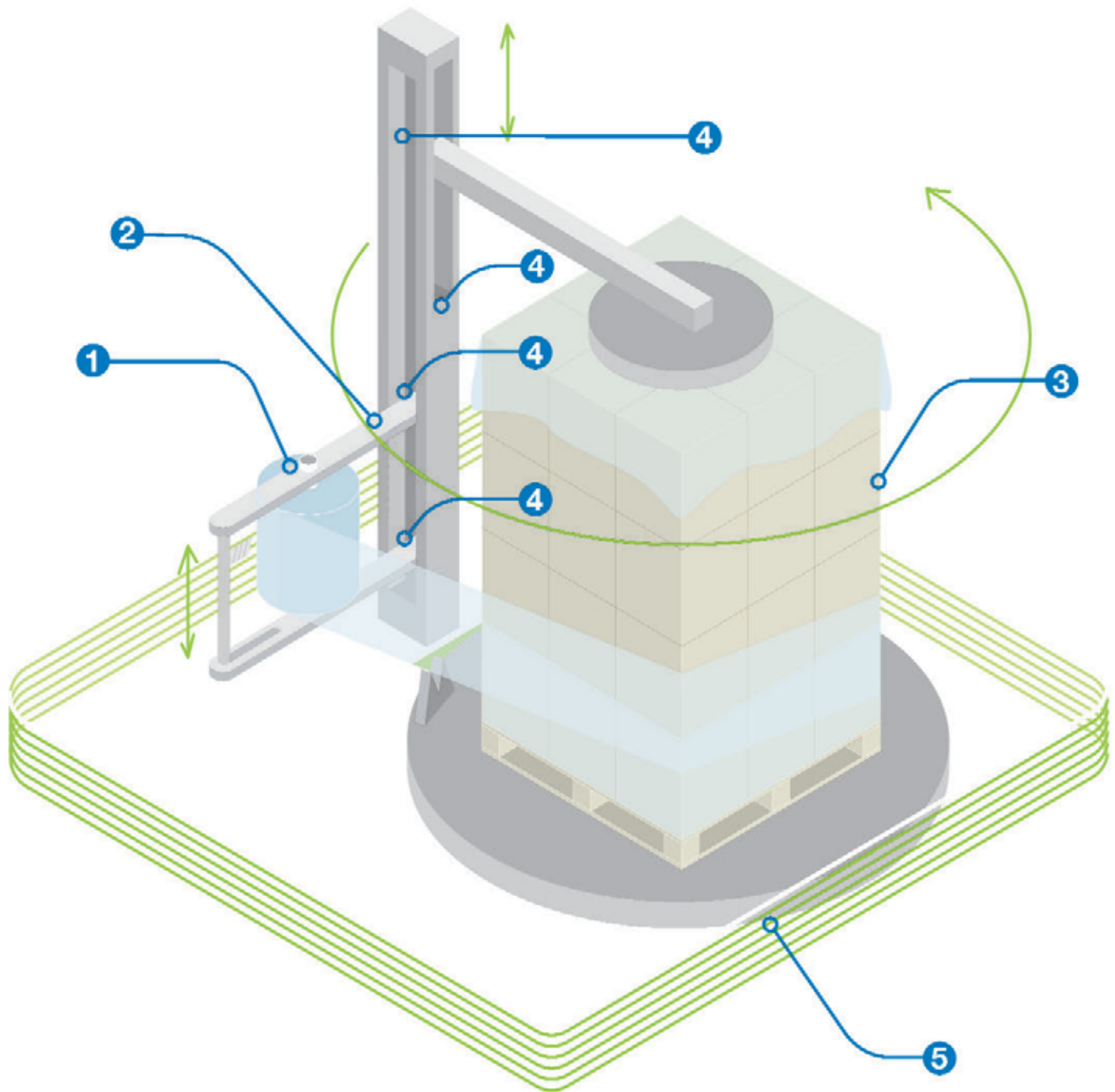



> Film presence

- To detect the presence of the film or to get the permanent status the use of ultrasonic sensors XX is the best solution because transparency or color of the object have no influence.
Flat or cylindrical formats are available.
- **UNIVERSAL:** XX7V1 with solid state or XX9V1 with analog output, mountable with bracket or simply in a hole Ø 18 mm.

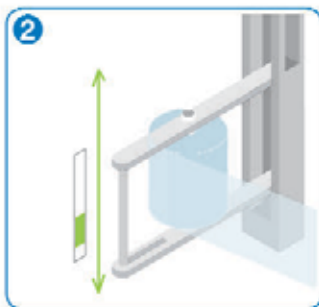

> Height positioning

- If a precise positioning of the film role is needed photo-electric or ultrasonic sensors are a good choice.
- **NEW:** Laser distance sensor XUE for a precise distance measurement, in diffuse or reflex version available.

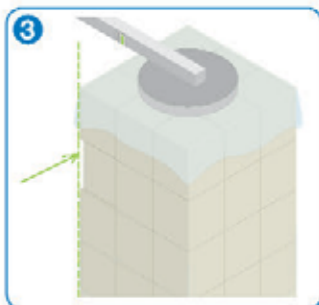

> Detection package overhang

- The maximum size of the package which has to be wrapped is controlled by photo-electric sensors.
- **IDEAL:** Compact sensor XUX8 in diffuse or XUX9 in reflex mode for high distances.

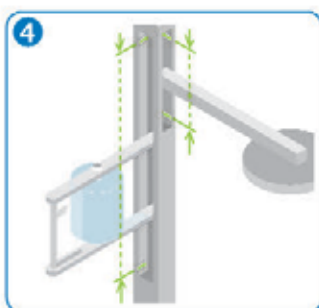

> Detection of the end positions

- To detect the end positions limit switches are the best choice.
- **IDEAL:** Compact limit switches XCKP or XCMD with modular design fit to all mechanical requirements.

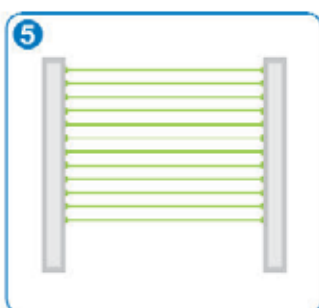

> Safety light curtains

- Whenever it is a matter of safeguarding machines without safety doors, safety light curtains XUSL are the right solution.



Telemecanique Sensors

Schneider Electric USA, Inc.
Schneider Electric
Sensor Competency Center
1875 Founders Drive
Dayton, Ohio 45420
(800) 435-2121

Schneider Electric Canada, Inc.
5985 McLaughlin Road
Mississauga, Ontario L5R 1B8
(800) 435-2121

www.seensors.com

The information provided in this documentation contains general descriptions and/or technical characteristics of the performance of the products contained herein. This documentation is not intended as a substitute for and is not to be used for determining suitability or reliability of these products for specific user applications. It is the duty of any such user or integrator to perform the appropriate and complete risk analysis, evaluation and testing of the products with respect to the relevant specific application or use thereof. Neither Schneider Electric nor any of its affiliates or subsidiaries shall be responsible or liable for misuse of the information contained herein.

Design: Schneider Electric
Photos: Schneider Electric